

**robot coupe®****CL 50 A**

Voltages <i>Voltages</i>	Dernier numéro de fabrication <i>Last serial number</i>	Date d'arrêt de la fabrication <i>Discontinued date</i>
220 / 50 / 1	92 / 9794	24 / 03 / 1993
240 / 50 / 1	92 / 9795	24 / 03 / 1993
115 / 60 / 1	92 / 2931	11 / 03 / 1993

**robot coupe**

**CL 50 A**

SOMMAIRE  
SUMMARY

PRIX  
PRICE

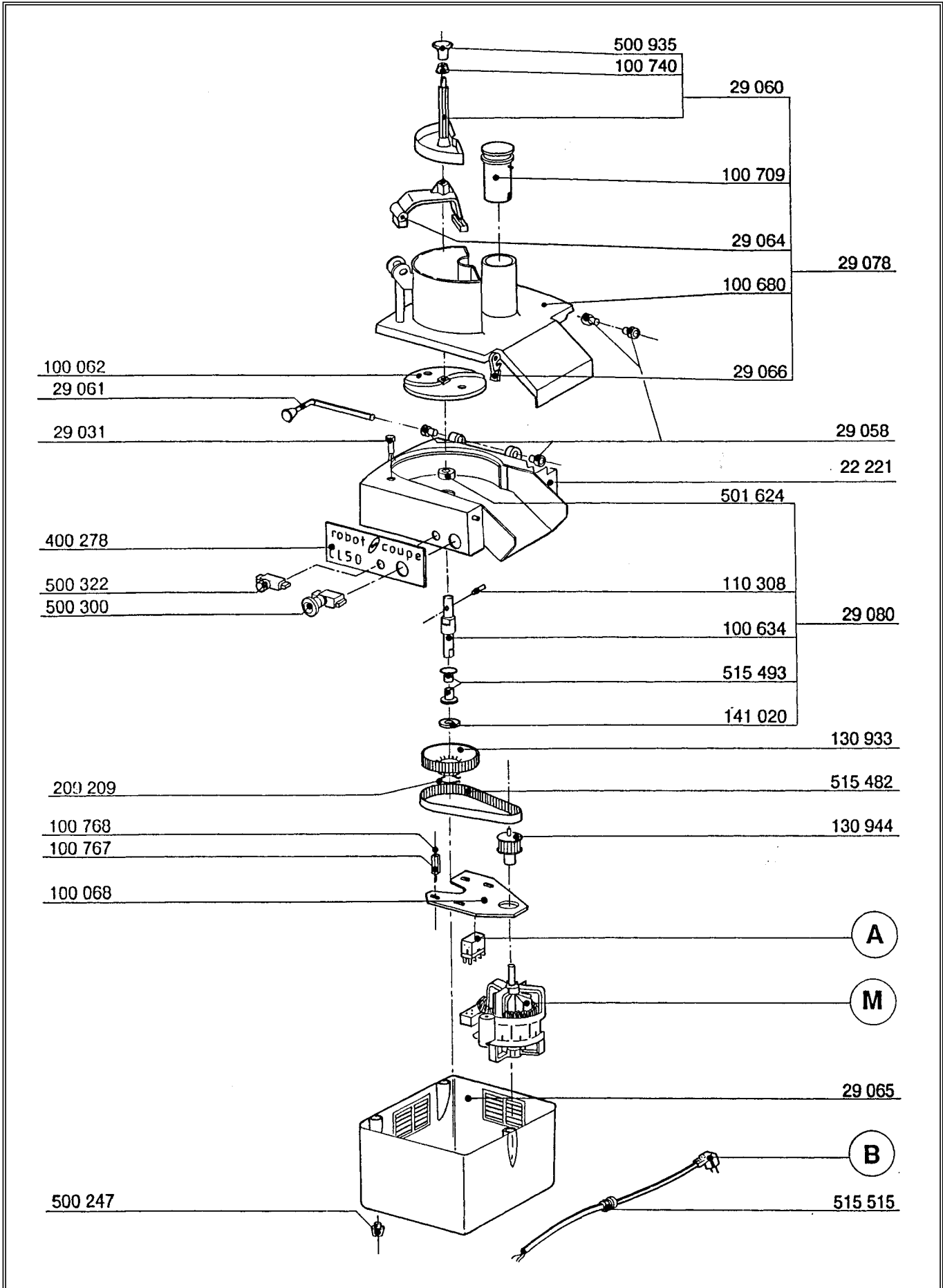

**CL 50 A**
**A**

RELAIS SECURITE

/ SECURITY RELAY

**B**

CABLE D'ALIMENTATION

/ POWER CORD

**M**

MOTEUR

/ MOTOR



CONDENSATEUR MOTEUR

/ MOTOR CAPACITOR



RELAIS MOTEUR

/ MOTOR RELAY

**REFERENCE****DESIGNATION**

29 031	ENS I L S AVEC SUPPORT	/ REED SWITCH ASS
29 058	ENS BAGUES EPAULEES (4)	/ SHOULDERED RING ASS (4)
29 060	ENS POUSSOIR LEGUMES	/ VEGETABLE PUSHER ASS
29 061	ENS TIGE DE VERROU	/ LOCKING ROD ASS
29 064	ENS GUIDE POUSSOIR LEG	/ PUSHER GUIDE ASS
29 065	ENS CAPOT AVEC PIEDS	/ BASE WITH FEET ASS
29 066	ENS TAQUET D'ACCROCHAGE	/ CLINCH CLIP ASS
29 078	ENS COUVERCLE	/ LID ASS
29 080	ENS ARBRE DE TRANSMISSION	/ TRANSMISSION SHAFT ASS
29 221	ENS CUVE	/ BOWL ASS
100 062	DISQUE EVACUATEUR	/ SLING PLATE
100 068	PLAQUE SUPPORT MOTEUR	/ MOTOR SUPPORT PLATE
100 634	ARBRE DE TRANSMISSION	/ SHAFT
100 680	COUVERCLE COUPE LEGUMES	/ VEGETABLE SLICER LID
100 709	POUSSOIR CAROTTES	/ CARROT PUSHER
100 740	REHAUSSE POIGNEE	/ KNOB WASHER
100 767	ENTRETOISE	/ BRACE
100 768	GOUJON	/ STUD
110 308	GOUPILLE D'AXE MOTEUR	/ MOTOR SHAFT PIN
130 933	POULIE DENTEE 75 DENTS	/ PULLEY ( 75 teeth )
130 944	POULIE MOTRICE 20 DENTS	/ PULLEY ( 20 teeth )
141 020	RONDELLE DE FROTTEMENT	/ RUBBING WASHER
209 209	CIRCLIPS	/ BUSHING
400 278	PLAQUE FRONTALE	/ FRONT PLATE
500 247	PIEDS GRIS	/ GREY FOOT
500 300	BOUTON ROUGE	/ RED KNOB
500 322	BOUTON VERT	/ GREEN KNOB
500 935	POIGNEE FIXE	/ HANDLE KNOB
501 624	BAGUE D'ETANCHEITE	/ SEAL RING
515 482	COURROIE	/ BELT
515 493	BAGUE AUTO-LUBRIFIANTE	/ RING
515 515	PRESSE ETOUPE	/ CORD PROTECTOR

**robot coupe®****CL 50 A**

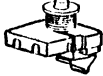
N°	M	V	H <sup>Z</sup>			A	B
24 044	3009	220	50	600 018	500 289	509 124	507 320
24 045	3010	240	50	600 018	500 289	509 124	500 543
24 047	3011	115	60	603 669	500 296	509 135	503 206
24 048	3010	240	50	600 018	500 289	509 124	500 468
24 049	3 063	220	60	603 669	500 289	500 560	507 320

**robot coupe®****CL 50 B**

Voltages <i>Voltages</i>	Premier numéro de fabrication <i>First serial number</i>	Date début de la fabrication <i>First date of production</i>
220 / 50 / 1	83 / 1201	10 / 02 / 1993
240 / 50 / 1	83 / 2413	15 / 02 / 1993
115 / 60 / 1	83 / 02	11 / 03 / 1993
220 / 60 / 1	83 / 2903	17 / 03 / 1993

**robot coupe**



**CL 50 B**

SOMMAIRE  
SUMMARY

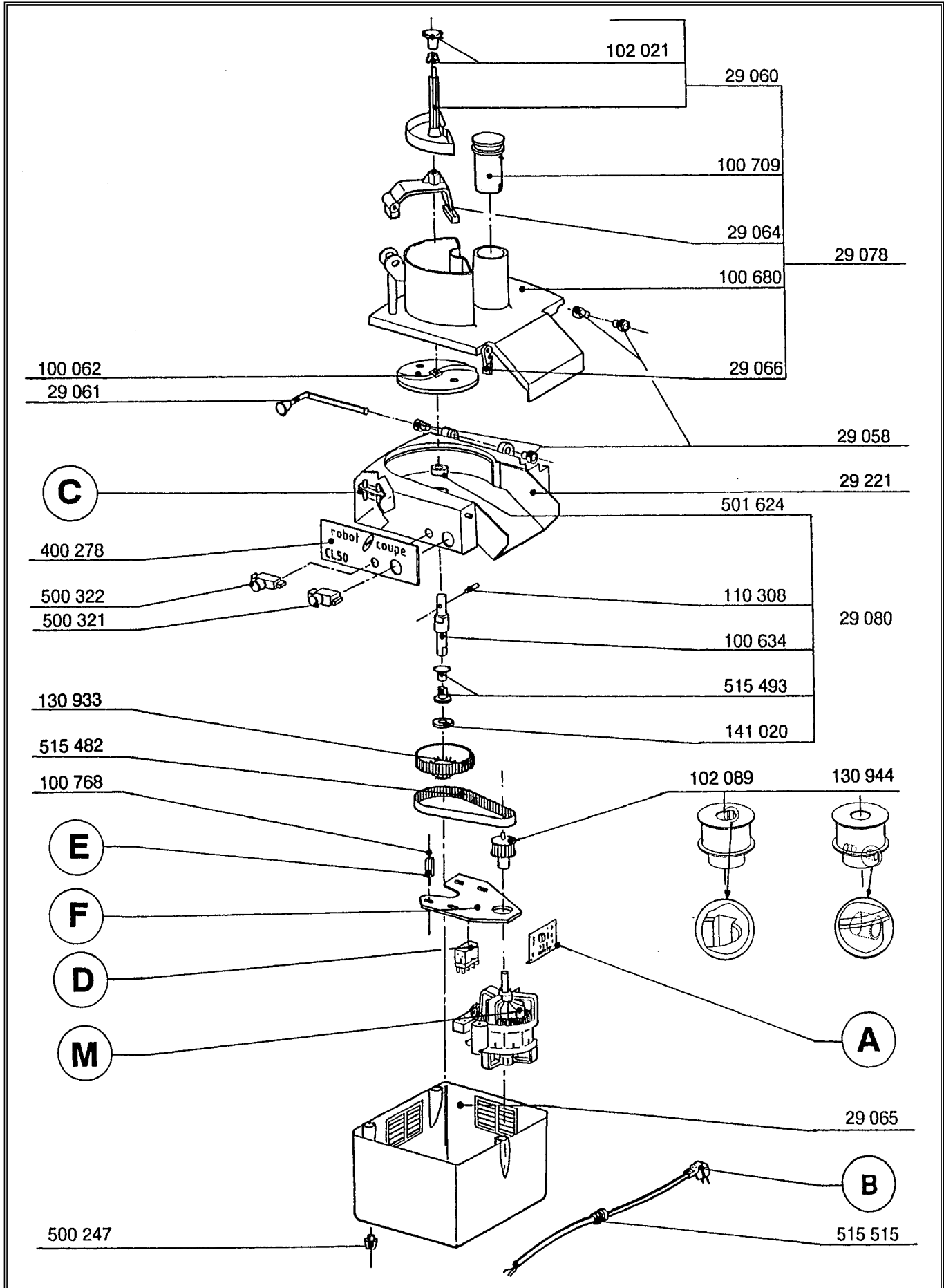
PRIX  
PRICE





**CL 50 B**



<b>A</b>	PLATINE	/	CIRCUIT BOARD
<b>B</b>	CABLE D'ALIMENTATION	/	POWER CORD
<b>C</b>	ILS ASS	/	RED SWITCH ASS
<b>D</b>	CONTACTEUR	/	CONTACTOR
<b>E</b>	ENTRETOISE	/	BRACE
<b>F</b>	PLAQUE SUPPORT MOTEUR	/	MOTOR SUPPORT PLATE
<b>M</b>	MOTEUR	/	MOTOR
	CONDENSATEUR MOTEUR	/	MOTOR CAPACITOR
	RELAIS MOTEUR	/	MOTOR RELAY

REFERENCE	DESIGNATION
29 058	ENS BAGUES EPAULEES (4) / SHOULDERED RING ASS (4)
29 060	ENS POUSSOIR LEGUMES / VEGETABLE PUSHER ASS
29 061	ENS TIGE DE VERROU / LOCKING ROD ASS
29 064	ENS GUIDE POUSSOIR LEG / PUSHER GUIDE ASS
29 065	ENS CAPOT AVEC PIEDS / BASE WITH FEET ASS
29 066	ENS TAQUET D'ACCROCHAGE / CLINCH CLIP ASS
29 078	ENS COUVERCLE / LID ASS
29 080	ENS ARBRE DE TRANSMISSION / TRANSMISSION SHAFT ASS
29 221	ENS CUVE / BOWL ASS
100 062	DISQUE EVACUATEUR / SLING PLATE
100 634	ARBRE DE TRANSMISSION / SHAFT
100 680	COUVERCLE COUPE LEGUMES / VEGETABLE SLICER LID
100 709	POUSSOIR CAROTTES / CARROT PUSHER
100 768	GOUJON / STUD
102 021	POIGNEE POUSSOIR / PUSHER HANDLE
102 089	POULIE MOTRICE 20 DENTS / PULLEY ( 20 teeth )
110 308	GOUPILLE D'AXE MOTEUR / MOTOR SHAFT PIN
130 933	POULIE DENTEE 75 DENTS / PULLEY ( 75 teeth )
130 944	POULIE MOTRICE 20 DENTS / PULLEY ( 20 teeth )
141 020	RONDELLE DE FROTTEMENT / RUBBING WASHER
400 278	PLAQUE FRONTALE / FRONT PLATE
500 247	PIEDS GRIS / GREY FOOT
500 321	BOUTON ROUGE / RED KNOB
500 322	BOUTON VERT / GREEN KNOB
501 624	BAGUE D'ETANCHEITE / SEAL RING
515 482	COURROIE / BELT
515 493	BAGUE AUTO-LUBRIFIANTE / RING
515 515	PRESSE ETOUPE / CORD PROTECTOR

**CL 50 B**
**MONOPHASE/SINGLE PHASE**

N°	M	V	HZ			A	B	C	E	F
24 081	3 064	220	50	600 018	500 289	102 471	507 322	29 261	100 767	100 068
24 082UK	3 065	240	50	600 018	500 289	102 471	507 325	29 261	100 767	100 068
24 083	3 066	115	60	603 669	500 296	102 470	507 329	29 261	100 767	100 068
24 084	3 067	220	60	603 669	500 289	102 471	507 322	29 261	100 767	100 068
24 085Aust	3 065	240	50	600 018	500 289	102 471	507 327	29 261	100 767	100 068
24 086	3 011	115	60	603 669	500 296	—	507 328	29 261	100 767	100 068
24 088	3 065	240	50	600 018	500 289	102 471	507 322	29 261	100 767	100 068

**TRIPHASE/THREE PHASE**

N°	M	V	HZ			A	B	C	D	E	F
24 176	303 025	415	50	—	—	—	502 067	29 459	503 921 + 500 553	101 437	101 361
24 177	303 028	220	60	—	—	—	502 067	29 459	503 888 + 500 553	101 437	101 361
24 178	303 026	380	60	—	—	—	502 067	29 459	507 650 + 500 553	101 437	101 361
24 179	303 025	380	50	—	—	—	502 067	29 459	507 650 + 500 553	101 437	101 361



**CL 50 C**

Voltages	Premier numéro de fabrication	Date de fabrication
<i>Voltages</i>	<i>First serial number</i>	<i>Date of production</i>
220 / 50 / 1	125 / 1 / 101	10 / 1997
240 / 50 / 1	125 / 2 / 901	10 / 1997
115 / 60 / 1	125 / 3 / 1	11 / 1997
220 / 60 / 1	125 / 4 / 1101	01 / 1998
220 / 50 / 3	125 / 15 /	01 / 1998
220 / 60 / 3	125 / 13 / 1301	01 / 1998
380 / 50 / 3	125 / 11 / 1451	01 / 1998
415 / 50 / 3	125 / 12 / 1541	01 / 1998
380 / 60 / 3	125 / 14 / 1601	01 / 1998
<i>et / and</i>		
230 / 50 / 1	T1250111101	Début / <i>early</i>  2000
240 / 50 / 1	T1250111102	
115 / 60 / 1	T1250111103	
220 / 60 / 1	T1250111104	
400 / 50 / 3	T1250111111	
415 / 50 / 3	T1250111112	
220 / 60 / 3	T1250111113	
380 / 60 / 3	T1250111114	
230 / 50 / 3	T1250111115	

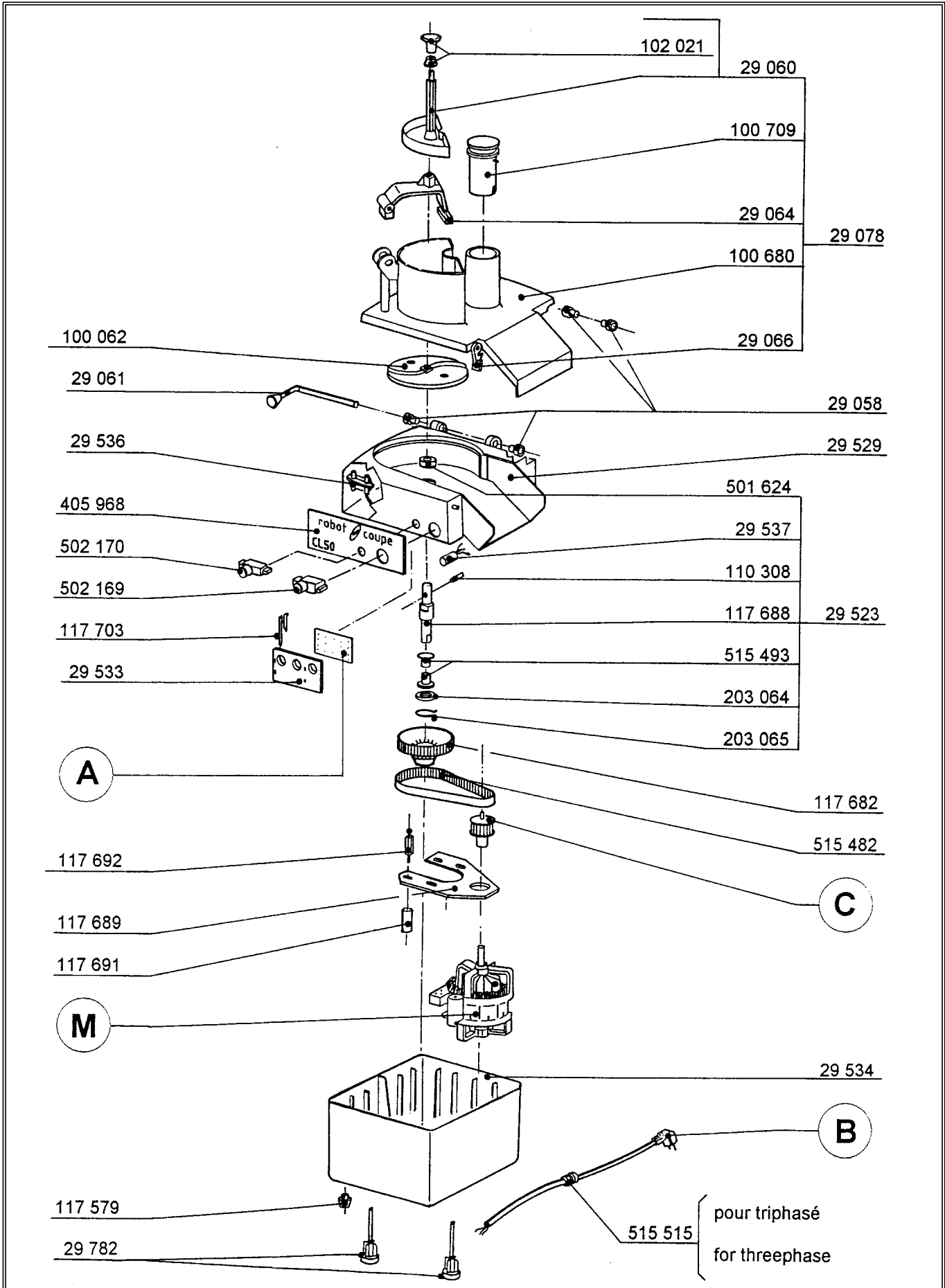



**CL 50 C**

**PLATINE / CIRCUIT BOARD**

**CABLE D'ALIMENTATION / POWER CORD**

**ENS POULIE MOTRICE 20 DENTS / PULLEY (20 teeth) ASS**

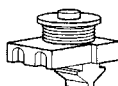
**MOTEUR / MOTOR**

**CONDENSATEUR MOTEUR / MOTOR CAPACITOR**

**RELAIS MOTEUR / MOTOR RELAY**
**REFERENCE**
**DESIGNATION**

29 058	ENS BAGUES EPAULEES (4)	/	SHOULDERED RING ASS (4)
29 060	ENS POUSSOIR LEGUMES	/	VEGETABLE PUSHER ASS
29 061	ENS TIGE VERROU	/	LOCKING ROD ASS
29 064	ENS GUIDE POUSSOIR LEG	/	PUSHER GUIDE ASS
29 066	ENS TAQUET ACCROCHAGE	/	CLINCH CLIP ASS
29 078	ENS COUVERCLE	/	LID ASS
29 523	ENS ARBRE DE TRANSMISSION	/	TRANSMISSION SHAFT ASS
29 529	ENS CUVE	/	BOWL ASS
29 533	ENS SUPPORT PLATINE	/	CIRCUIT BOARD SUPPORT ASS
29 534	ENS CAPOT AVEC LES PIEDS	/	BASE WITH FEET ASS
29 536	ENS ILS POUSSOIR	/	PUSHER ILS ASS
29 537	ENS ILS COUVERCLE	/	LID ILS ASS
29 782	ENS VIS DE SOCLE	/	BASE SCREWS
100 062	DISQUE EVACUATEUR	/	SLING PLATE
100 680	COUVERCLE COUPE LEGUMES	/	VEGETABLE SLICER LID
100 709	POUSSOIR CAROTTES	/	CARROT PUSHER
102 021	POIGNEE POUSSOIR	/	PUSHER HANDLE
110 308	GOUPILLE D'AXE MOTEUR	/	MOTOR SHAFT PIN
117 579	PIED CL50C	/	CL50C FOOT
117 682	POULIE DENTEE 75 DENTS	/	PULLEY (75 teeth)
117 688	ARBRE DE TRANSMISSION	/	SHAFT
117 689	PLAQUE SUPPORT MOTEUR	/	MOTOR SUPPORT PLATE
117 691	ENTRETOISE CAPOT	/	BASE BRACE
117 692	ENTRETOISE SUPPORT	/	SUPPORT BRACE
117 703	CLAVETTE PLATINE	/	CIRCUIT BOARD PIN
203 064	RONDELLE DE FROTTEMENT	/	RUBBING WASHER
203 065	CIRCLIPS	/	BUSHING
405 968	PLAQUE FRONTALE	/	FRONT PLATE
501 624	BAGUE D'ETANCHEITE	/	SEAL RING
502 169	BOUTON ROUGE	/	RED KNOB
502 170	BOUTON VERT	/	GREEN KNOB
515 482	COURROIE	/	BELT
515 493	BAGUE AUTO-LUBRIFIANTE	/	RING
515 515	PRESSE ETOUPE	/	CORD PROTECTOR

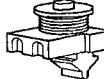
**CL 50 C**
MONOPHASE/SINGLE PHASE

N°	M	V	Hz			A	B	C
24 257	3 095	115	60	603 669	500 296	102 480	507 027	29 530
24 258	3 096	220	50	600 018	500 289	102 480	507 026	29 530
25 259	3 097	220	60	603 669	500 289	102 480	507 026	29 530
24 261 Aust	3 096	240	50	600 018	500 289	102 480	507 028	29 530
24 262 UK	3 096	240	50	600 018	500 289	102 480	507 029	29 530
24 278	3 096	240	50	600 018	500 289	102 480	507 026	29 530

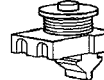
TRIPHASE/THREE PHASE

N°	M	V	Hz			A	B	C
24 260	303 038	220	60	-	-	102 479	515 570	29 532
24 263	303 035	380	50	-	-	102 479	515 570	29 532
24 264	303 037	380	60	-	-	102 479	515 570	29 532
24 265	303 035	415	50	-	-	102 479	515 570	29 532

**CL 50 D**

Voltages	Premier numéro de fabrication	Date de fabrication
<i>Voltages</i>	<i>First serial number</i>	<i>Date of production</i>
230 / 50 / 1	T1900111101	Début / <i>early</i>  2000
240 / 50 / 1	T1900111102	
115 / 60 / 1	T1900111103	
220 / 60 / 1	T1900111104	
400 / 50 / 3	T1900111111	
220 / 60 / 3	T1900111113	
380 / 60 / 3	T1900111114	

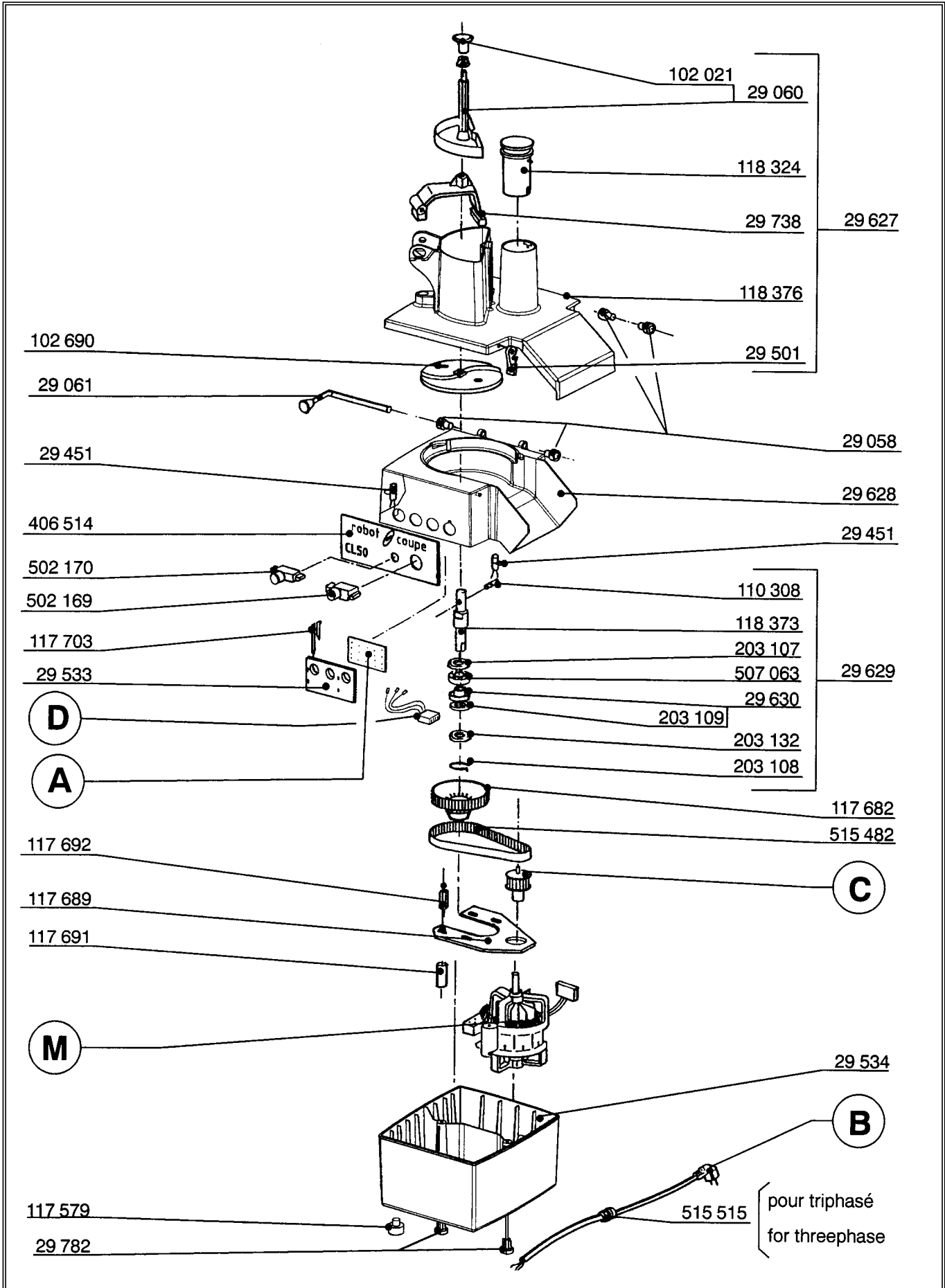

**CL 50 D**

REFERENCE	DESIGNATION
29 058	ENS BAGUES EPAULEES (4) / SHOULDERED RING ASS (4)
29 060	ENS POUSSOIR LEGUMES / VEGETABLE PUSHER ASS
29 061	ENS TIGE VERROU / LOCKING ROD ASS
29 451	ENS ILS / ILS ASS
29 501	ENS TAQUET ACCROCHAGE / CLINGH CLIP ASS
29 533	ENS SUPPORT PLATINE / CIRCUIT BOARD SUPPORT ASS
29 534	ENS CAPOT AVEC LES PIEDS / BASE WITH FEET ASS
29 627	ENS COUVERCLE / LID ASS
29 628	ENS CUVE / BOWL ASS
29 629	ENS ARBRE DE TRANSMISSION / TRANSMISSION SHAFT ASS
29 630	ENS ROUL. COMBINE / COMBIMATE BEARING ASS
29 738	ENS GUIDE POUSSOIR LEG / PUSHER GUIDE ASS
29 782	ENS VIS DE SOCLE / BASE SCREWS
102 021	POIGNEE POUSSOIR / PUSHER HANDLE
102 690	DISQUE EVACUATEUR / SLING PLATE
110 308	GOUPILLE D'AXE MOTEUR / MOTOR SHAFT PIN
117 579	PIED CL50C / CL50C FOOT
117 682	POULIE DENTEE 75 DENTS / PULLEY (75 teeth)
117 689	PLAQUE SUPPORT MOTEUR / MOTOR SUPPORT PLATE
117 691	ENTRETOISE CAPOT / BASE BRACE
117 692	ENTRETOISE SUPPORT / SUPPORT BRACE
117 703	CLAVETTE PLATINE / CIRCUIT BOARD PIN
118 324	POUSSOIR CAROTTES / CARROT PUSHER
118 373	ARBRE DE TRANSMISSION / SHAFT
118 376	COUVERCLE COUPE LEGUMES / VEGETABLE SLICER LID
203 107	JOINT / RING
203 108	CIRCLIPS / BUSHING
203 109	RONDELLE DE FROTTEMENT / RUBBING WASHER
203 132	RONDELLE / WASHER
406 514	PLAQUE FRONTALE / FRONT PLATE
502 169	BOUTON ROUGE / RED KNOB
502 170	BOUTON VERT / GREEN KNOB
507 063	ROULEMENT / BEARING
515 482	COURROIE / BELT
515 515	PRESSE ETOUPE / CORD PROTECTOR



CL 50 D

**A**

PLATINE

/ CIRCUIT BOARD

**B**

CABLE D'ALIMENTATION

/ POWER CORD

**C**

ENS POULIE MOTRICE 20 DENTS

/ PULLEY (20 teeth) ASS

**D**

FAISCEAU DE CONNEXION

/ CONNECTION BEAM

**M**

MOTEUR

/ MOTOR



CONDENSATEUR MOTEUR

/ MOTOR CAPACITOR

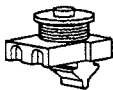

RELAIS MOTEUR

/ MOTOR RELAY

MONOPHASE/SINGLE PHASE

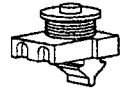
N°	M	V	Hz			A	B	C	D
24 340	3 114	230	50	600 018	500 289	102 480	507 026	29 530	29 599
24 341 UK	3 114	240	50	600 018	500 289	102 480	507 029	29 530	29 599
24 342 Aust	3 114	240	50	600 018	500 289	102 480	507 028	29 530	29 599
24 343	3 116	220	60	603 669	500 289	102 480	507 026	29 530	29 599
24 344	3 115	115	60	603 669	500 296	102 480	507 027	29 530	29 599

TRIPHASE/THREE PHASE

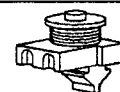
N°	M	V	Hz			A	B	C	D
24 345	303 080	400	50	-	-	102 479	515 570	29 532	29 600
24 346	303 077	220	60	-	-	102 479	515 570	29 532	29 600
24 347	303 078	380	60	-	-	102 479	515 570	29 532	29 600



**CL 50 C Ultra**

Voltages	Premier numéro de fabrication	Date de fabrication
<i>Voltages</i>	<i>First serial number</i>	<i>Date of production</i>
220 / 50 / 1	126 / 1 / 61	10 / 1997
240 / 50 / 1	126 / 2 / 361	10 / 1997
115 / 60 / 1	126 / 3 / 1	
220 / 60 / 1	126 / 4 / 461	01 / 1998
220 / 50 / 3	126 / 15 / 3590	
220 / 60 / 3	126 / 13 / 521	01 / 1998
380 / 50 / 3	126 / 11 / 641	09 / 1997
415 / 50 / 3	126 / 12 / 581	01 / 1998
380 / 60 / 3	126 / 14 / 551	01 / 1998
<i>et / and</i>		
230 / 50 / 1	T1260111101	
240 / 50 / 1	T1260111102	
220 / 60 / 1	T1260111104	
400 / 50 / 3	T1260111111	Début / <i>early</i>
415 / 50 / 3	T1260111112	2000
220 / 60 / 3	T1260111113	
380 / 60 / 3	T1260111114	
230 / 50 / 3	T1260111115	

**robot coupe**

**CL 50 C Ultra**

SOMMAIRE  
SUMMARY

PRIX  
PRICE

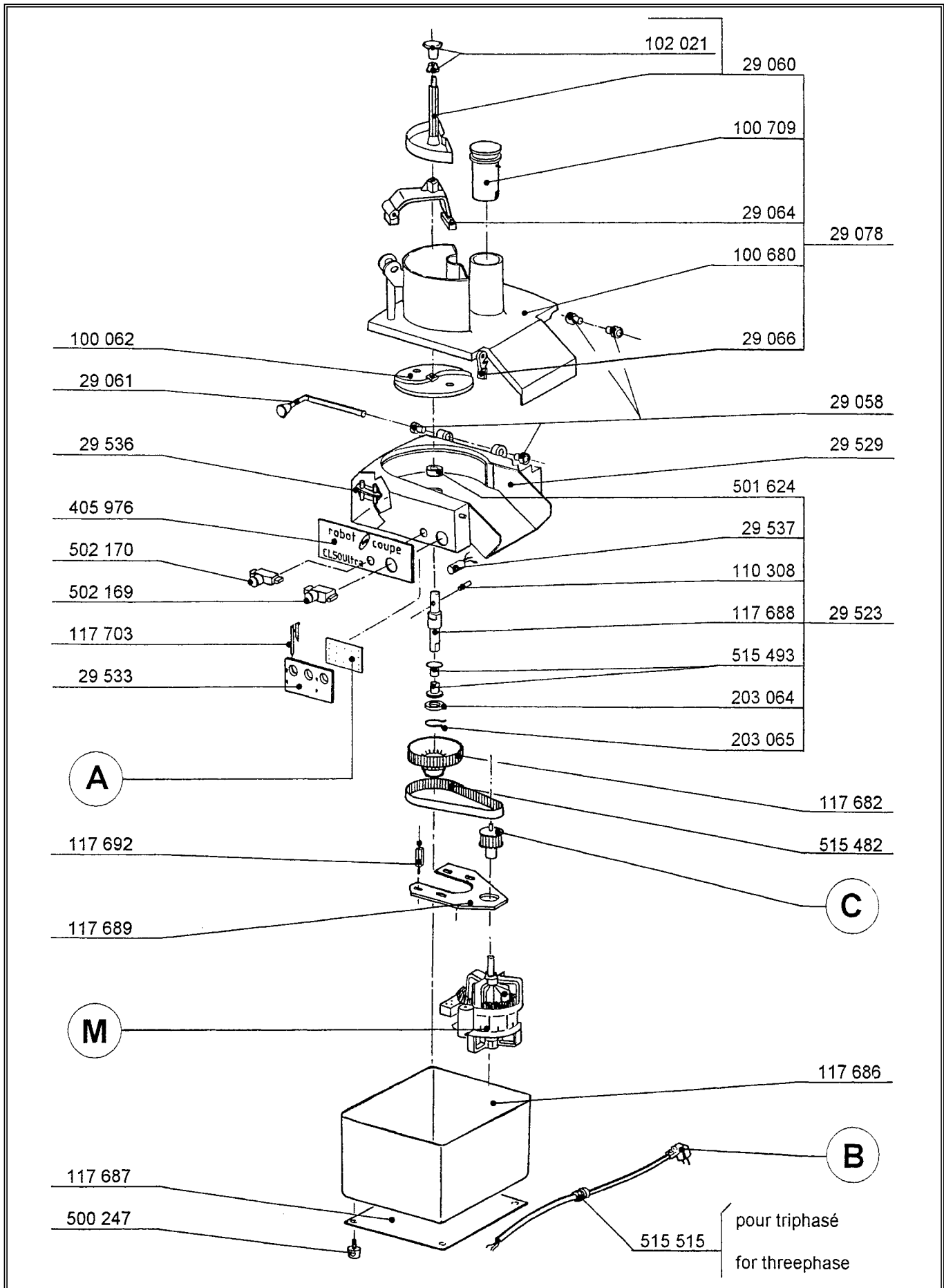



**CL 50 C Ultra**

**PLATINE / CIRCUIT BOARD**

**CABLE D'ALIMENTATION / POWER CORD**

**ENS POULIE MOTRICE 20 DENTS / PULLEY (20 teeth) ASS**

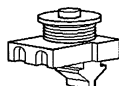
**MOTEUR / MOTOR**

**CONDENSATEUR MOTEUR / MOTOR CAPACITOR**

**RELAIS MOTEUR / MOTOR RELAY**
**REFERENCE**
**DESIGNATION**

29 058	ENS BAGUES EPAULEES (4)	/	SHOULDERED RING ASS (4)
29 060	ENS POUSSOIR LEGUMES	/	VEGETABLE PUSHER ASS
29 061	ENS TIGE VERROU	/	LOCKING ROD ASS
29 064	ENS GUIDE POUSSOIR LEG	/	PUSHER GUIDE ASS
29 066	ENS TAQUET ACCROCHAGE	/	CLINCH CLIP ASS
29 078	ENS COUVERCLE	/	LID ASS
29 523	ENS ARBRE DE TRANSMISSION	/	TRANSMISSION SHAFT ASS
29 529	ENS CUVE	/	BOWL ASS
29 533	ENS SUPPORT PLATINE	/	CIRCUIT BOARD SUPPORT ASS
29 536	ENS ILS POUSSOIR	/	PUSHER ILS ASS
29 537	ENS ILS COUVERCLE	/	LID ILS ASS
100 062	DISQUE EVACUATEUR	/	SLING PLATE
100 680	COUVERCLE COUPE LEGUMES	/	VEGETABLE SLICER LID
100 709	POUSSOIR CAROTTES	/	CARROT PUSHER
102 021	POIGNEE POUSSOIR	/	PUSHER HANDLE
110 308	GOUPILLE D'AXE MOTEUR	/	MOTOR SHAFT PIN
117 682	POULIE DENTEE 75 DENTS	/	PULLEY (75 teeth)
117 686	CAPOT	/	COVER BASE
117 687	PLAQUE DE FOND	/	BOTTOM PLATE
117 688	ARBRE DE TRANSMISSION	/	SHAFT
117 689	PLAQUE SUPPORT MOTEUR	/	MOTOR SUPPORT PLATE
117 692	ENTRETOISE SUPPORT	/	SUPPORT BRACE
117 703	CLAVETTE PLATINE	/	CIRCUIT BOARD PIN
203 064	RONDELLE DE FROTTEMENT	/	RUBBING WASHER
203 065	CIRCLIPS	/	BUSHING
405 976	PLAQUE FRONTALE	/	FRONT PLATE
500 247	PIEDS GRIS	/	GREY FOOT
501 624	BAGUE D'ETANCHEITE	/	SEAL RING
502 169	BOUTON ROUGE	/	RED KNOB
502 170	BOUTON VERT	/	GREEN KNOB
515 482	COURROIE	/	BELT
515 493	BAGUE AUTO-LUBRIFIANTE	/	RING
515 515	PRESSE ETOUPE	/	CORD PROTECTOR

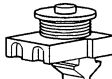
**CL 50 C Ultra**
**MONOPHASE/SINGLE PHASE**

N°	M	V	Hz			A	B	C
24 267	3 095	115	60	603 669	500 296	102 480	507 027	29 530
24 268	3 096	220	50	600 018	500 289	102 480	507 026	29 530
25 269	3 097	220	60	603 669	500 289	102 480	507 026	29 530
24 271 Aust	3 096	240	50	600 018	500 289	102 480	507 028	29 530
24 272 UK	3 096	240	50	600 018	500 289	102 480	507 029	29 530
24 279	3 096	240	50	600 018	500 289	102 480	507 026	29 530
24 285 ISR	3 096	240	50	600 018	500 289	102 480	507 026	29 530

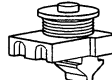
**TRIPHASE/THREE PHASE**

N°	M	V	Hz			A	B	C
24 270	303 038	220	60	-	-	102 479	515 570	29 532
24 273	303 035	380	50	-	-	102 479	515 570	29 532
24 274	303 037	380	60	-	-	102 479	515 570	29 532
24 275	303 035	415	50	-	-	102 479	515 570	29 532
24 276 ISR	303 035	380	50	-	-	102 479	515 570	29 532

**CL 50 D Ultra**

Voltages	Premier numéro de fabrication	Date de fabrication
<i>Voltages</i>	<i>First serial number</i>	<i>Date of production</i>
230 / 50 / 1	T1910111101	Début / <i>early</i>  2000
240 / 50 / 1	T1910111101	
220 / 60 / 1	T1910111104	
400 / 50 / 3	T1910111111	
220 / 60 / 3	T1910111113	
380 / 60 / 3	T1910111114	

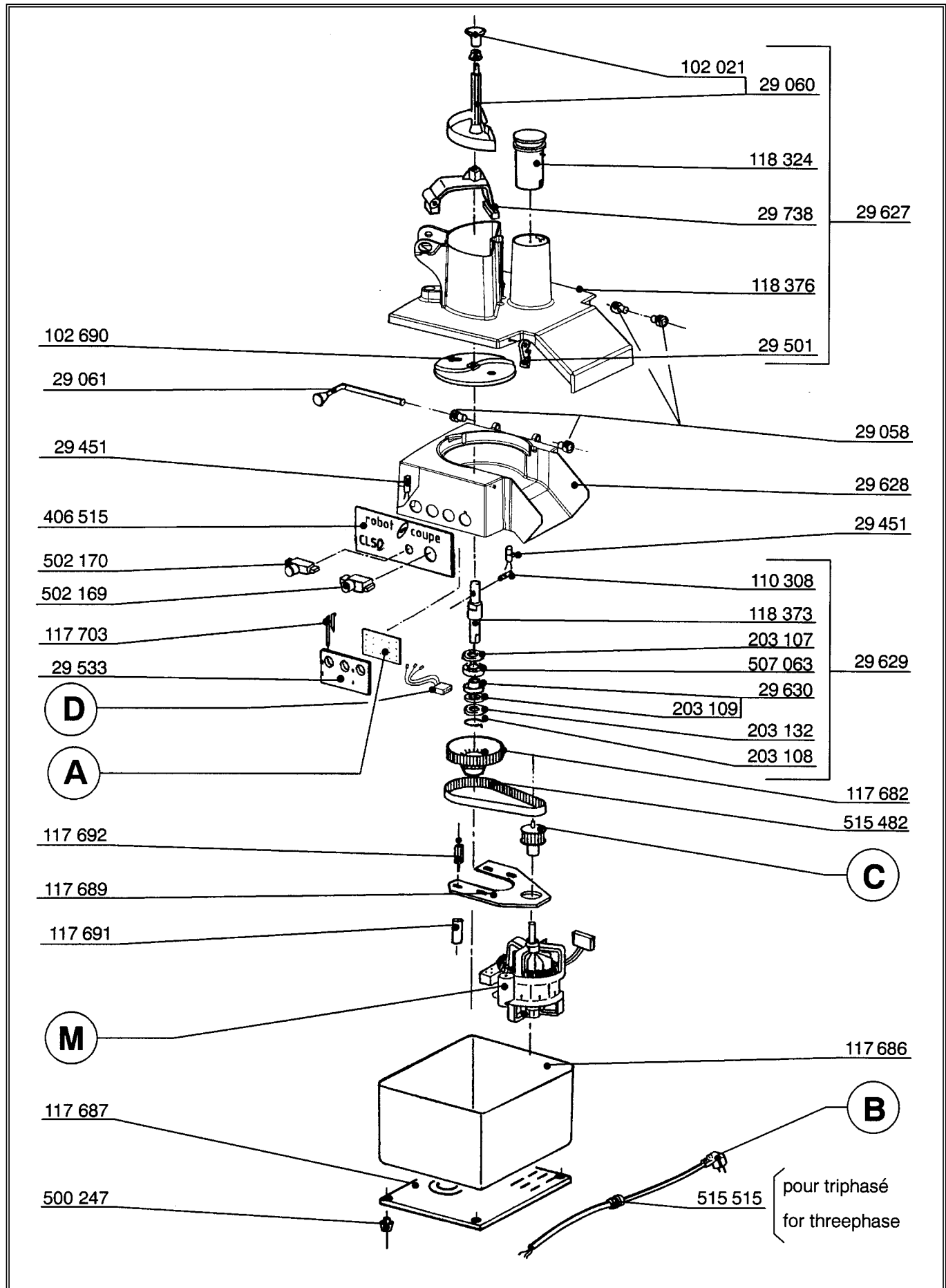

**CL 50 D Ultra**

REFERENCE	DESIGNATION	
29 058	ENS BAGUES EPAULEES (4)	/ SHOULDERED RING ASS (4)
29 060	ENS POUSSOIR LEGUMES	/ VEGETABLE PUSHER ASS
29 061	ENS TIGE VERROU	/ LOCKING ROD ASS
29 451	ENS ILS	/ ILS ASS
29 501	ENS TAQUET ACCROCHAGE	/ CLINGH CLIP ASS
29 533	ENS SUPPORT PLATINE	/ CIRCUIT BOARD SUPPORT ASS
29 627	ENS COUVERCLE	/ LID ASS
29 628	ENS CUVE	/ BOWL ASS
29 629	ENS ARBRE DE TRANSMISSION	/ TRANSMISSION SHAFT ASS
29 630	ENS ROUL. COMBINE	/ COMBIMATE BEARING ASS
29 738	ENS GUIDE POUSSOIR LEG	/ PUSHER GUIDE ASS
102 021	POIGNEE POUSSOIR	/ PUSHER HANDLE
102 690	DISQUE EVACUATEUR	/ SLING PLATE
110 308	GOUPILLE D'AXE MOTEUR	/ MOTOR SHAFT PIN
117 579	PIED CL50C	/ CL50C FOOT
117 682	POULIE DENTEE 75 DENTS	/ PULLEY (75 teeth)
117 686	CAPOT	/ COVER BASE
117 687	PLAQUE DE FOND	/ BOTTOM PLATE
117 689	PLAQUE SUPPORT MOTEUR	/ MOTOR SUPPORT PLATE
117 692	ENTRETOISE SUPPORT	/ SUPPORT BRACE
117 703	CLAVETTE PLATINE	/ CIRCUIT BOARD PIN
118 324	POUSSOIR CAROTTES	/ CARROT PUSHER
118 373	ARBRE DE TRANSMISSION	/ SHAFT
118 376	COUVERCLE COUPE LEGUMES	/ VEGETABLE SLICER LID
203 107	JOINT	/ RING
203 108	CIRCLIPS	/ BUSHING
203 109	RONDELLE DE FROTTEMENT	/ RUBBING WASHER
203 132	RONDELLE	/ WASHER
406 515	PLAQUE FRONTALE	/ FRONT PLATE
500 247	PIEDS GRIS	/ GREY FOOT
502 169	BOUTON ROUGE	/ RED KNOB
502 170	BOUTON VERT	/ GREEN KNOB
507 063	ROULEMENT	/ BEARING
515 482	COURROIE	/ BELT
515 515	PRESSE ETOUPE	/ CORD PROTECTOR

**CL 50 D Ultra**
**A**

PLATINE

/ CIRCUIT BOARD

**B**

CABLE D'ALIMENTATION

/ POWER CORD

**C**

ENS POULIE MOTRICE 20 DENTS

/ PULLEY (20 teeth) ASS

**D**

FAISCEAU DE CONNEXION

/ CONNECTION BEAM

**M**

MOTEUR

/ MOTOR



CONDENSATEUR MOTEUR

/ MOTOR CAPACITOR

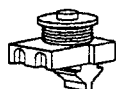



RELAIS MOTEUR

/ MOTOR RELAY

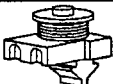
MONOPHASE/SINGLE PHASE

N°	M	V	Hz			A	B	C	D
24 350	3 114	230	50	600 018	500 289	102 480	507 026	29 530	29 599
24 351 UK	3 114	240	50	600 018	500 289	102 480	507 029	29 530	29 599
24 352 Aust	3 114	240	50	600 018	500 289	102 480	507 028	29 530	29 599
24 353	3 116	220	60	603 669	500 289	102 480	507 026	29 530	29 599
24 254	3 115	115	60	603 669	500 296	102 480	507 027	29 530	29 599

TRIPHASE/THREE PHASE

N°	M	V	Hz			A	B	C	D
24 355	303 080	400	50	-	-	102 479	515 570	29 532	29 600
24 356	303 077	220	60	-	-	102 479	515 570	29 532	29 600
24 357	303 078	380	60	-	-	102 479	515 570	29 532	29 600